



Analysis of Neutron Absorber Materials on the Safety Parameters in the RSG-GAS Reactor

Lily Suparlina^{1*}, Tukiran Surbakti¹, Surian Pinem¹, Purwadi²

¹Center for Nuclear Reactor Technology and Safety, BATAN, Kawasan Puspiptek Gd.80, Tangerang Selatan, 15314, Banten, Indonesia,

²Center for Multipurpose Reactor, BATAN, Kawasan Puspiptek Building Gd. 31, Tangerang Selatan 15314, Banten, Indonesia

ARTICLE INFO

Article history:

Received: 16 March 2021

Received in revised form: 17 April 2021

Accepted: 28 April 2021

Keywords:

Silicide fuel

Neutron absorber

Safety parameters

AgInCd

B4C

Hf material

ABSTRACT

The shutdown system in the core of the RSG-GAS reactor uses a neutron absorber material. Research reactors in the world often use 3 kinds of neutron absorber materials, namely AgInCd, B4C, and Hf. In this research, a neutron absorber analysis was carried out on the neutronic safety parameters for the RSG-GAS reactor core. Neutronic safety parameters for various kinds of neutron absorbing materials in the existing RSG-GAS core have never been carried out. The neutronic safety parameters are k_{eff} , neutron flux, core excess reactivity, shutdown margin, control rod total reactivity value, and PPF. A 250 gram silicide fuel was selected as a case study to see the possibility of a better neutron absorber material. In a three-dimensional diffusion model, four groups of neutron energies are selected for the computation of the core. The WIMSD-5B and Batan-3DIFF computer programs were used to perform this calculation. The calculation result shows that the largest shutdown margin value using B4C neutron absorber material; whereas the lowest PPF was obtained using Hf neutron absorbing material. The greatest power density values are in the fuel area around the CIP (center irradiation position), surrounded by the control fuel element, and the standard fuel element beside the beryllium reflector. The largest and smallest fluctuations in power density were obtained using neutron absorber materials B4C and AgInCd, respectively.

© 2021 Tri Dasa Mega. All rights reserved.

1. INTRODUCTION

RSG-GAS is a research reactor used for radioisotope production, nuclear energy training, material irradiation and the nuclear industry[1]. The RSG-GAS core consists of the standard fuel assembly, control rods, moderator, reflector, reactivity, shutdown control systems and experimental equipment. Each component, system,

equipment and device used must be in place and meet certain qualifications as to meet the needs of the current experimental program while meeting the requirements of the Operational Limits and Conditions (OLC). RSG-GAS is controlled by a control rod system (neutron absorber). The control rod system is a nuclear technology for initiating, maintaining and controlling the desired fission reactions in the core of the RSG-GAS reactor. The control rod system is a control tool of the fission process, which is very important for controlling the fission chain reaction in the core to remain active and preventing the acceleration of fission reactions out of control. The state of the fission chain reaction can be explained by the effective

* Corresponding author. Tel./Fax.: 021-7560912/021-7560913

E-mail: lilyrsg@batan.go.id

DOI: [10.17146/tdm.2021.23.2.6278](https://doi.org/10.17146/tdm.2021.23.2.6278)

multiplication factor, k_{eff} , which expresses the change in the total number of fission events from one successive generation to the next[2]. If RSG-GAS is in a stable state it has $k_{eff} = 1$, and it is said to be in a critical state. If $k < 1$, RSG-GAS is subcritical state. If $k > 1$, the state of the reactor becomes supercritical and the fission chain reaction will grow exponentially. Therefore, the most important Keff number for the RSG-GAS reactor is 1. The value of the multiplication factor $k_{eff} > 1$ (supercritical) is required when the RSG-GAS reactor wants to increase its power. A subcritical state is required when the RSG-GAS reactor lowers power or shuts down. Maintaining $k = 1$ is very difficult, because it requires a balance which is influenced by several factors[3]. The influencing factors are the fissile fuel used and the material or material from the reactor core itself, and the number of neutrons produced from each fission or the amount of neutron absorption by the fuel material, graphite or moderator. However, in reality the neutron balance basically changes, so the value of the effective multiplication factor in the reactor core will always vary from generation to generation, because many fission products are neutron absorbers (reactor toxins such as xenon and samarium) and always reduce the number of neutrons in the core. The control rod can be used as an effective method for dealing with time-dependent changes in neutrons in the reactor core. The control rod system is a very effective neutron absorber device, which can be actively pulled in or out of the core of the RSG-GAS reactor during fission. The part of the control rod that can interact with the fission reaction can be adjusted so that the value of the effective folding factor can be properly adjusted to keep the reactor critical. The control rod system can also be used to increase the power or turn off the reactor state, especially as a feature to shut down the reactor in an emergency manner by plugging the rod completely into the reactor core[4]. Each control rod device has a specific reactivity value, indicating its ability to absorb both high and low energy neutrons. The balance between shutdown reactivity value, reactor core overreactivity and control rod reactivity value must be designed in such a way as to meet the specified conditions and the reactor can be operated safely. The RSG-GAS core control rod contains a material that highly absorbs neutrons, so that the presence of the control rod will affect the significant neutron flux value in the reactor core irradiation facility. This flux change will basically change the reactivity value of the existing control rods, so that the number of individual control rod values can be significantly different from the collective

number[5]. This difference is due to the interaction effect between control rods. The determination of the magnitude of this interaction effect is important for the safety of the reactor core operation. Calculation of changes in control rod reactivity and their effects on operating safety must be predicted and compared with calculated results accurately or measured parameters to ensure that there is sufficient reactivity margin at all times. So that, it can be ascertained that the reactor can be shutdown safely[6, 7]. The RSG-GAS reactor core shutdown system currently uses AgInCd neutron absorber material. There is a possibility that the RSG-GAS reactor uses other types of neutron absorber materials, namely B4C and Hf[8, 9]. In this activity, an analysis of the neutron absorber material in the RSG-GAS core was carried out on the neutronic safety parameters. Neutronic safety parameters for various types of neutron absorbing materials in the existing RSG-GAS core have never been carried out. The neutronic safety parameters are core excess reactivity, shutdown margin, control rod total reactivity value, PPF and neutron flux. RSG-GAS core 250 gram silicidal fuel was chosen as a case study to see the possibility of a better neutron absorber. In a three-dimensional diffusion model, four groups of neutron energies are selected for the computation of the core. The WIMSD-5B[10, 11] and Batan-3DIFF[12, 13] computer programs were used to perform this calculation.

2. BRIEF DESCRIPTION OF RSG-GAS

The RSG-GAS research reactor[14, 15] is an MTR (Material Testing Reactor) type which is designed to use uranium oxide as fuel. Currently, it uses uranium silicide. RSG-GAS is cooled and moderated by light water, it uses beryllium as a reflector material. The reactor can operate at a nominal power of 30 MW, using 19.75% low enriched U fuel element. The core configuration used (Figure 1) has a 10×10 grid consisting of 40 Standard Fuel Elements (SFE), 8 Fuel Control Elements (CFE), beryllium refektor blocks and 4 irradiation positions (IP) and 1 central irradiation position (CIP) which consists of (H₂O + Al). The fuel element consists of 21 SFE type fuel plates and 15 CFE type fuel plates. The 3 left-hand side plates and a separate area right in the CFE are used for the fork type AgInCd blade absorber. Figure 2 and 3 show the standard fuel element and control rod fuel element, respectively. The reactor core was fed into a pool of light water, cooled by forced convection in a downward direction. Table 1 summarizes the main parameters of the RSG-GAS reactor core.

Table 1. Main parameter of the RSG-GAS[16]

Parameter	Values
Fuel elements amount	40
Control elements amount	8
Absorbers amount	8
Length of Cycle, MWD	630
Average fuel burnup, BOC, % loss of ^{235}U	25.61
Average burnup, EOC, % loss of ^{235}U	32.54
Average discharged fuel burnup, % loss of ^{235}U	55.60
Max. burnup, % loss of ^{235}U	59.99
Core excess reactivity at BOC, %	7.58
Reactivity for experiments, %	2.00
Total control rods reactivity, %	- 14.00
Shut-down reactivity margin, %	- 2.45
Stuck rod condition, %	$\geq - 0.5$
Fuel temperature coefficient, $\% \Delta k/k$	-1.82×10^{-5}
Moderator temperature coefficient, $\% \Delta k/k$	-7.50×10^{-5}
Moderator void coefficient, $\% \Delta k/k$	-1.36×10^{-3}
Delayed neutron fraction	7.186×10^{-3}
Lifetime for prompt fission neutrons, μs	64.51

3. METHODOLOGY

The calculation of the core using the Batan-3DIFF program is using the diffusion method which requires geometry, dimensions and macroscopic x-section data. X-section data were obtained using the WIMSD-5B computer program. Winfrith Improved Multi-group Scheme (WIMS) is a program for calculating reactor core lattice cells in various commonly used reactor systems. Specifically, the computer program has facilities for rod or plate fuel geometry either in the form of a regular array or in clusters or assemblies such as RSG-GAS core fuel. The structure of the neutron energy group has been chosen primarily for cell calculations using 4 energy groups. Basically the WIMSD-5B program cross-section library has been compiled with 14 fast groups, 13 resonance groups, and 42 thermal groups, but the user is offered a choice of accurate solutions in multiple groups or quick calculations in multiple groups. In general, thermal scattering matrices which are highly temperature dependent for various scattering laws are included in the literature for moderators and reactor core coolants which include hydrogen, beryllium, and oxygen. The neutron resonance energy treatment is based on the use of the equivalence theorem with a resonance integral library that evaluates accurately for an equivalent homogeneous system at various temperature states.

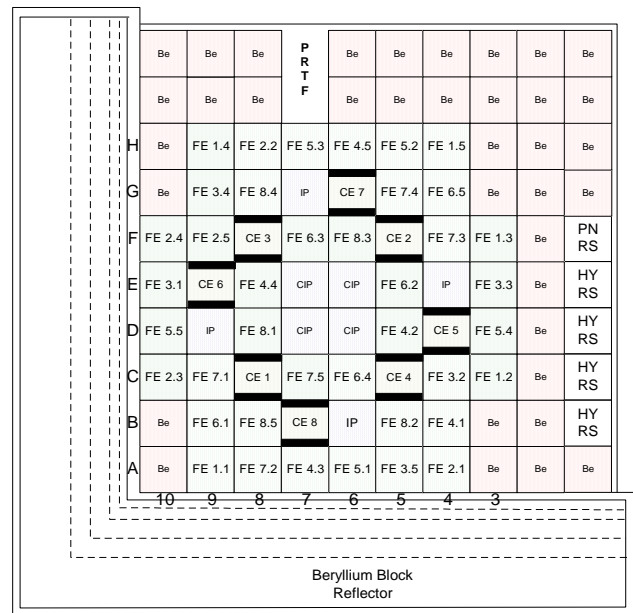
**Fig. 1.** Core configuration of RSG-GAS[16]

The collision theory procedure provides accurate spectral calculations in the 69 library energy groups for the main areas of the lattice using simplified geometric representations of complex lattice cells. The calculated spectrum is then used for the cross-sectional condensation of the 4 selected neutron energy groups for the solution of the transport equation in detailed geometry. Transport equation solutions are provided using the Carlson DSN method. The code output provides the cell mean parameter to be used in calculating the reactor core as a whole. In this work, the macroscopic cross-section for each core zone was calculated based on the PERSEUS method introduced in plate geometry (plate type). The WIMSD-5B library file used in this study was created using the Nuclear Data Bank ENDF/B-VII.1[17]. Four partitions from a basic 69-group were selected to homogenize cell data and accommodate integral parameters using the FEWGROUPS card. The upper energy group boundaries are selected as follows: 10 MeV, 0.821 MeV, 5.531 KeV, and 0.625 eV. The radial and axial bending inputs to the WIMSD-5B are $9.170063\text{E-}03 \text{ cm}^{-2}$ and $1.764000\text{E-}03 \text{ cm}^{-2}$, respectively. They are derived taking into account the geometric buckling of a parallelepiped rectangle with a height of 60 cm and a side length of 40.27 cm with an extrapolated thickness of 8 cm. After generating group constants for all reactor core components, then they are entered into the Batan-3DIFF code to model the reactor core in three dimensions (x-y-z). The flux is normalized to 30 MW throughout the reactor core. Bend the axial $1.709 \times 10^{-3} \text{ cm}^2$ according to the distribution of the chopped cosine axial flux with a reflector save about 8 cm. The core benchmark (Figure 1) is made

of various reactor core elements, including: Standard Fuel Element (SFE), Control Fuel Element (CFE), central irradiation position (central whole water), surrounding water, and beryllium reflector. The Batan-3DIFF code solves the energy multi-group neutron diffusion equation (up to three) to calculate the effective multiplication factor, power density, and neutron flux distribution in the reactor core. It uses a different numerical method to iteratively based on a specified control volume to solve the diffusion equation. The maximum relative change of the flux factor and the multiplication was set at 1.0E-5 for the last iteration as the convergence criterion. The calculation of three-dimensional diffusion and four groups of neutron energies determines the zone identification of 19 regions in the x direction and 19 regions towards y, and 5 regions towards z which are vertical columns from top to bottom.

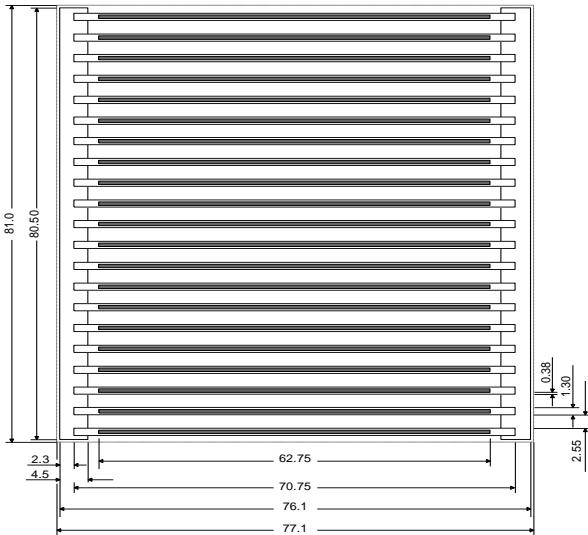

Fig. 2. Standard fuel element of RSG-GAS[16]

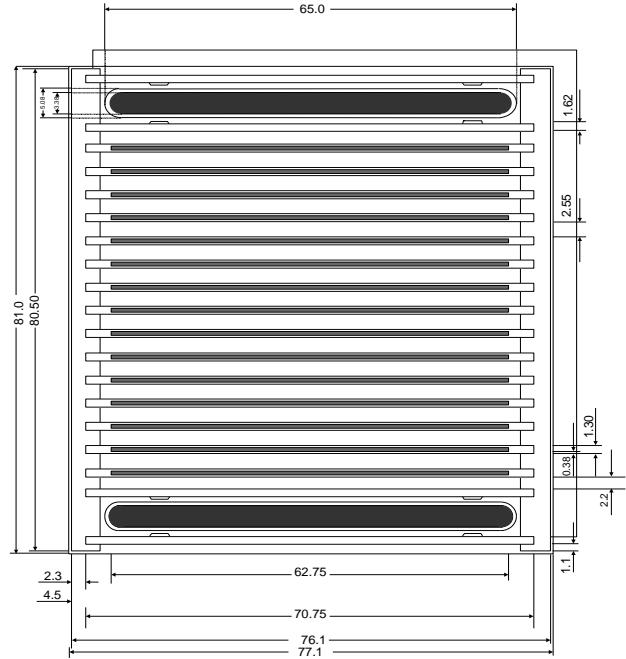

Fig. 3. Control rod fuel element of RSG-GAS[16]

4. RESULTS AND DISCUSSION

Results from WIMSD-5B calculation can be seen on Table 2, 3 and 4. The results present the macroscopic x-section for absorber materials including Ag-In-Cd, B₄C, and Hf. The parameter contains diffusion coefficients (D), absorption cross sections (Σ_a), and total removal cross sections (Σ_r). These parameter were required to run the Batan-3DIFF code. The greatest coefficient diffusion is achieved by B₄C material as absorber and then HF and AgInCd, respectively.

Table 2. X-section of HF material

WIMS ID	Energy group	X- section	
38	1	1.93136E+00	3.92735E-03
		0.00000E+00	0.00000E+00
		0.00000E+00	1.23280E-01
		4.52550E-02	1.32170E-04
38	2	3.53250E-11	
		1.04904E+00	2.48314E-02
		0.00000E+00	0.00000E+00
		0.00000E+00	0.00000E+00
38	3	2.91940E-01	9.78800E-04
		0.00000E+00	
		0.00000E+00	0.00000E+00
		0.00000E+00	4.27470E-01
38	4	1.99680E-04	
		4.78622E-02	6.71464E+00
		0.00000E+00	0.00000E+00
		0.00000E+00	0.00000E+00
		0.00000E+00	1.28280E-03
		2.48520E-01	

Table 3. X-section of B4C material

WIMS ID	Energy group	X- section	
38	1	4.76814E+00	7.91776E-04
		0.00000E+00	0.00000E+00
		0.00000E+00	5.91602E-02
		9.95647E-03	2.95887E-08
		0.00000E+00	
38	2	2.24429E+00	5.19309E-03
		0.00000E+00	0.00000E+00
		0.00000E+00	0.00000E+00
		1.40643E-01	2.68905E-03
		0.00000E+00	
38	3	1.69681E+00	2.97342E-02
		0.00000E+00	0.00000E+00
		0.00000E+00	0.00000E+00
		0.00000E+00	1.66713E-01
		2.45365E-14	
38	4	1.64217E-01	1.93569E+00
		0.00000E+00	0.00000E+00
		0.00000E+00	0.00000E+00
		0.00000E+00	2.70805E-03
		9.14423E-02	

Table 4. X-section of AgInCd material

WIMS ID	Energy group	X- section	
38	1	1.78542E+00	3.78971E-03
		0.00000E+00	0.00000E+00
		0.00000E+00	1.16105E-01
		6.67942E-02	8.18047E-06
		1.85283E-15	
38	2	1.03188E+00	2.11113E-02
		0.00000E+00	0.00000E+00
		0.00000E+00	0.00000E+00
		3.01889E-01	3.44945E-05
		0.00000E+00	
38	3	7.01538E-01	1.01246E-01
		0.00000E+00	0.00000E+00
		0.00000E+00	0.00000E+00
		0.00000E+00	3.73900E-01
		6.51999E-15	
38	4	6.71075E-02	4.90320E+00
		0.00000E+00	0.00000E+00
		0.00000E+00	0.00000E+00
		0.00000E+00	8.83642E-03
		5.51184E-02	

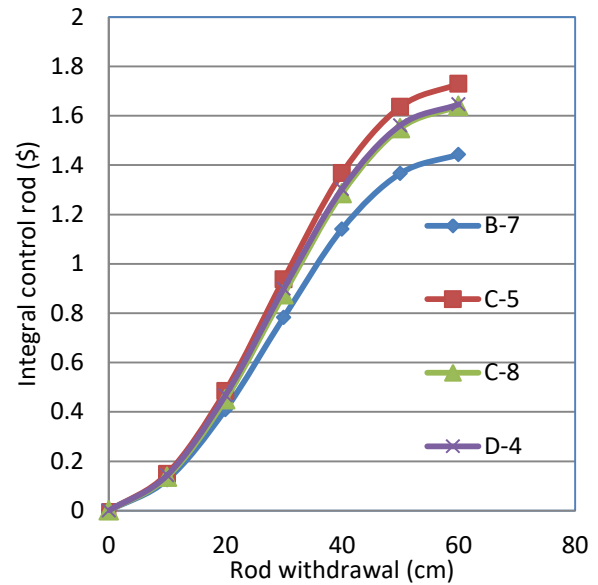

Fig. 4. Control rod reactivity worth of HF (JDA01-04)

Figures 4 shows the integral control rod worth of Hf material for JDA 01-04. S-curves of the result show that the neutron absorber appropriate to control the neutron flux in the core. The middle part of the curva is the most effective to absorb the neutron for the four control rods. The values of the individul control rods worth are B-7 = 1.443 \$, C-5 = 1.729 \$, C-8 = 1,639 \$, D-4 = 1,644 \$.

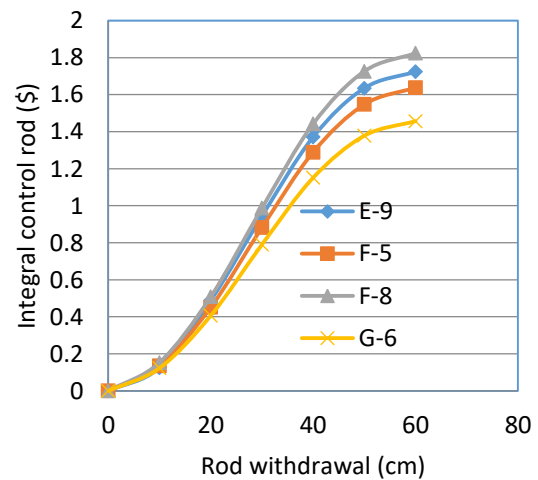

Fig 5. Control rod reactivity worth of HF (JDA05-08)

Figure 5 shows the integral control rod worth of Hf material for JDA 05-08. S-curves of the result also show that the neutron absorber appropriate to control the neutron flux in the core. The values of the individual control rods worth are E-9 = 1.724 \$, F-5 = 1.638 \$, F-8 = 1.824 \$, and G-6 = 1.457 \$. The value of individual control rod worth for 8 control rods is around (1.65 ± 0.21) \$ for Hf material as a neutron absorber in RSG-GAS core.

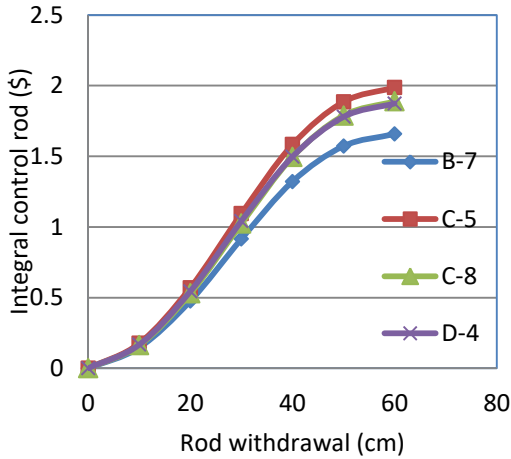

Fig. 6. Control rod reactivity of B₄C (JDA01-04)

Figure 6 shows the integral control rod worth of B₄C material for JDA 01-04. S-curves of the result also show that the neutron absorber appropriate to control the neutron flux in the core. The middle part of the curve is the most effective to absorb the neutron. The values of the individual control rods worth are B-7 = 1.658 \$, C-5 = 1.987 \$, C-8 = 1,889 \$, D-4 = 1,874 \$.

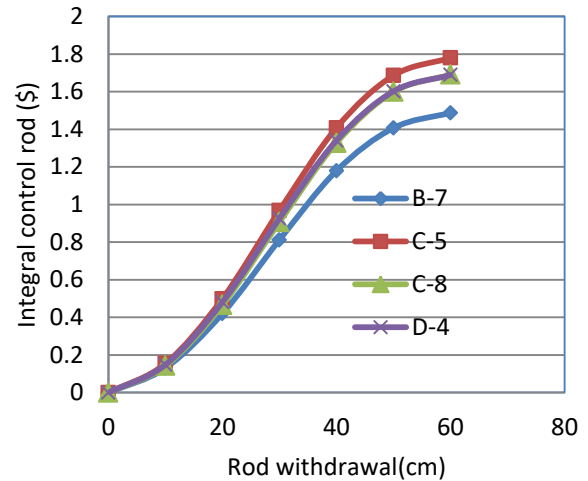

Fig. 8. Control rod reactivity of AgInCd (JDA01-04)

Figure 8 shows the integral control rod worth of AgInCd material for JDA01-04. S-curves of the result also show that the neutron absorber appropriate to control the neutron flux in the core. The middle part of the curve is the most effective to absorb the neutron. The values of the individual control rods worth are B-7 = 1.488 \$, C-5 = 1.780 \$, C-8 = 1,691 \$, D-4 = 1,689 \$.

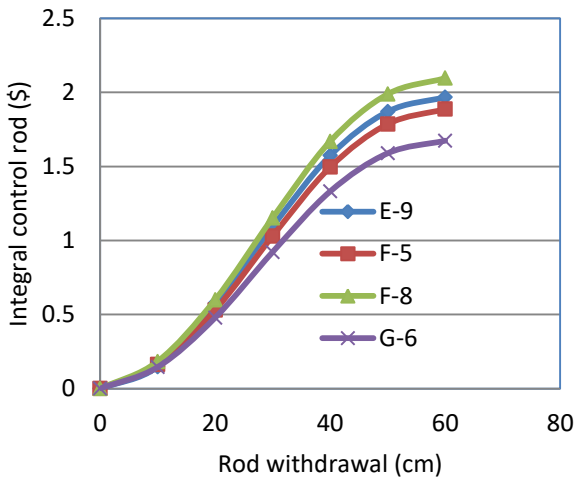

Fig. 7. Control rod reactivity of B₄C (JDA05-08)

Figure 7 shows the integral control rod worth of B₄C material for JDA 05-08. S-curves of the result also show that the neutron absorber appropriate to control the neutron flux in the core. The middle part of the curve is the most effective to absorb the neutron. The values of the individual control rods worth are E-9 = 1.968 \$, F-5 = 1.887 \$, F-8 = 2.096 \$, and G-6 = 1.674 \$. The value of individual control rod worth is around (1.85 ± 0.25) \$ for B₄C material as a neutron absorber in RSG-GAS core.

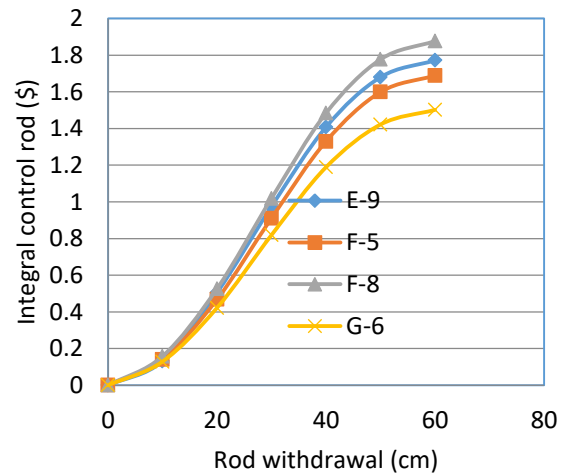

Fig. 9. Control rod reactivity of AgInCd (JDA05-08)

Figure 9 shows the integral control rod worth of AgInCd material for JDA01-04. S-curves shows that the neutron absorber appropriate to control the neutron flux in the core. The middle part of the curve is the most effective one to absorb the neutron. The values of the individual control rods worth are E-9 = 1.722 \$, F-5 = 1.689 \$, F-8 = 1.877 \$, and G-6 = 1.502 \$. The value of individual control rod worth is around (1.69 ± 0.20) \$ for AgInCd material as a neutron absorber in RSG-GAS core. The S curve for the third materials show that the design is correct because of the control rod shape, and $\Delta\rho/\Delta h$ parameter can be calculated as a slope value. This slope value also shows the positive reactivity amount

given to the RSG-GAS core per cm of control rod withdrawal.

The individual and total control rods reactivity of the RSG-GAS core can be seen on Table 5. The control rods' reactivity worth was obtained from calculation using WISD-5B/Batan-3DIFF codes. The total value of control rod reactivity among calculation differs because the x-section of the material differ. The biggest value of total integral control worth is for material B4C and lowest value is for HF material as a absorber in RSG-GAS core. This table showed that the calculation model had been done well.

Table 6. Total control rod worth

Total integral control rods (\$)		
Hf	B4C	AgInCd
17.446	20.941	18.118

Table 6 shows that the value of total integral control rod for material Hf, B₄C and AgInCd. The biggest value of total integral control rod also come from material B₄C because the sigma absorpsion are also the biggest one. The calculation result is also depended on X-section which calculated from WIMSD-5B code. The important thing also comes from calculation results of total integral control rod and summation of individual control rod (Table 5). The different result of calculation between Tabel 5 and 6 is because of interaction of 8 control rods and also shadowing effect in the core.

Table 5. Control rod reactivity worth of AgInCd, B4C and Hf materials

Absorber material	Reactivity control rod (\$)								Total (\$)
	B-7	C-5	C-8	D-4	E-9	F-5	F-8	G-6	
AgInCd	1.488	1.780	1.691	1.689	1.772	1.689	1.877	1.502	13.488
B4C	1.658	1.987	1.889	1.874	1.968	1.887	2.096	1.674	15.033
Hf	1.443	1.729	1.639	1.646	1.724	1.638	1.824	1.457	13.100

Figure 10 shows that the total integral control rod worth of Hf, B4C and AgInCd. S-curves of the result of calculation also show that the neutron absorber of 3 material appropriate to control the

neutron flux in the core. The middle part of the curve is the most effective to absorb the neutron in the core.

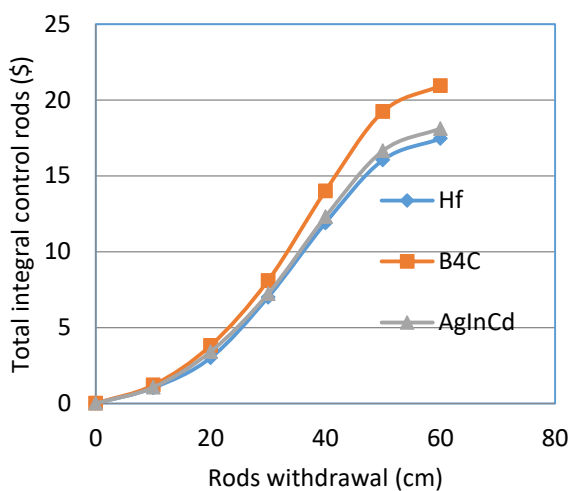

Fig. 10. Total control rod reactivity worth of AgInCd, B4C and Hf materials

Table 7. K-eff values for different absorber materials

Control rods position (cm)	K-eff			Core reactivity (%)		
	Hf	B ₄ C	AgInCd	Hf	B ₄ C	AgInCd
0	0.965107	0.940605	0.960281	-3.615	-6.315	-4.136
60	1.107796	1.107488	1.1077168	9.706	9.705	9.724

Table 7 shows the calculation result of k-eff value if all control rods fully down. The result of

calculations are k-eff = 0.965107, 0.940605, 0.940605 for material Hf, B₄C and AgInCd. Based

on the k-eff parameter it can be achieved the value of shutdown reactivity of the RSG-GAS core. If they are compared among those results, the B₄C material achieved the biggest value -6.316. This table also shows the result of k-eff values if all control rod fully up. The values of k-eff are

1.107796, 1.107488 and 1.1077168 for material Hf, B₄C and AgInCd as neutron absorber materials in RSG-GAS core. The values achieved excess reactivity of the core and they were almost the same 9.7 %.

Table 8. Thermal neutron flux in the irradiation positions

Absorbers	B-6	D-9	E-4	G-7	D-6	D-7	E-6	E-7
AgInCd	2.062E14	2.132E14	2.092E14	2.046E14	2.498E14	2.508E14	2.508E14	2.510E14
B ₄ C	2.060E14	2.129E14	2.044E14	2.044E14	2.496E14	2.506E14	2.506E14	2.508E14
Hf	2.062E14	2.134E14	2.093E14	2.046E14	2.498E14	2.508E14	2.508E14	2.509E14

Table 8 show the results of calculation for thermal neutron flux in irradiation facilities. In the RSG-GAS core, there are 8 irradiation facilities consist of 4 in the centre of the core and 4 around

the fuel in the core. The average thermal neutron flux values in the irradiation facilities change among three kind of neutron absorbers but not significant.

Table 9. PPF radial values for different absorber materials

Absorber	PPF (0 cm)	PPF (10 cm)	PPF (20 cm)	PPF (30 cm)	PPF (40 cm)	PPF (50 cm)	PPF (60 cm)
AgInCd	1.3066	1.3450	1.3066	1.2277	1.1844	1.1771	1.2157
	H-9	H-9	H-9	F-10	F-10	C-8	C-8
B ₄ C	1.3415	1.4107	1.3415	1.2329	1.1872	1.1733	1.2150
	H-9	H-9	H-9	F-10	F-10	C-8	C-8
Hf	1.2959	1.3263	1.2959	1.2244	1.1827	1.1787	1.2160
	H-9	H-9	H-9	F-10	F-10	C-8	C-8

The values of radial PPF (peak power factor) can be shown in Table 9. The biggest value was achieved at 10 cm from the bottom for all neutron absorber materials. The biggest value came from

B₄C material (1.4) and the lowest come from Hf material (1.3). The hottest part in core is the H-9 position, the same position with all neutron absorbers.

Table 10. PPF axial values for different absorber materials

Absorber	PPF (0 cm)	PPF (10 cm)	PPF (20 cm)	PPF (30 cm)	PPF (40 cm)	PPF (50 cm)	PPF (60 cm)
AgInCd	1.2854	1.4670	1.8386	1.7531	1.5627	1.4026	1.3041
	H-7	E-9	D-4	D-4	D-4	D-4	D-4
B ₄ C	1.2848	1.6307	1.9533	1.8165	1.5923	1.4148	1.3059
	H-7	D-4	D-4	D-4	D-4	D-4	D-4
Hf	1.2851	1.4164	1.8014	1.7312	1.5527	1.3980	1.3032
	H-7	E-9	D-4	D-4	D-4	D-4	D-4

The values of axial PPF can be shown in Table 10. The biggest value was achieved at 20 cm from the bottom for all neutron absorber materials. The biggest value came from B₄C material and the lowest come from Hf material. The hottest part in core is the D-4 position, the same position with all neutron absorbers.

5. CONCLUSION

Based on the analysis results, it was found that the largest to the smallest total reactivity value of control rods with B₄C, AgInCd and Hf materials and all of them met the applicable requirements, namely the ratio between total reactivity control rods and core excess reactivity is greater than 1.5. The highest shutdown margin was obtained using B₄C neutron absorber material. None of the axial and radial PPF values exceeded the limit but the

lowest was generated by the control rod using the Hf neutron absorber. B₄C is the most effective absorbent material; it can be used to obtain a greater reactivity shutdown margin. AgInCd can be used to reduce power heat fluctuation in irradiation facilities and fuel plates if all safety margins are maintained in each case. In order to select the best neutron absorber material for the neutron absorber control rods in the RSG-GAS core, a detailed and complete experimental test and analysis is still needed, including hot and cold tests of control rods in accordance with the specified regulations.

ACKNOWLEDGMENT

This research is supported by DIPA budget of 2021. The authors wish to thank the Head of PTKRN-BATAN for his kindly suggestion and the

coordinator of BFTR-PTKRN-BATAN for his kindly help and useful discussions when doing the research.

AUTHOR CONTRIBUTION

Lily Suparlina carried out cell calculation using WIMSD-5B, Tukiran Surbakti carried out core modelling in core calculation code, Puwadi supplied the operational data for RSG-GAS reactor. Surian Pinem participated as a reviewer and data analysis. Lily Suparlina, Surian Pinem and Tukiran Surbakti are the main contributors of this paper. All authors read and approved the final version of the manuscript.

REFERENCES

- Iliyasu U., Ibrahim Y. V, Umar S., Agbo S.A., Jibrin Y. An Investigation of Reactivity Effect Due to Inadvertent Filling of the Irradiation Channels with Water in NIRR-1 Nigeria Research Reactor-1. *Appl. Radiat. Isot.* 2017. **123**: 11-16.
- Dawahra S., Khattab K., Saba G. A Comparative Study of the Neutron Flux Spectra in the MNSR Irradiation Sites for the HEU and LEU Cores Using the MCNP4C Code. *Appl. Radiat. Isot.* 2015. **104**: 67-73.
- Dawahra S., Khattab K., Saba G. Calculation and Comparison of Xenon and Samarium Reactivities of the HEU, LEU Core in the Low Power Research Reactor. *Appl. Radiat. Isot.* 2015. **101**: 27-32.
- Liem P.H., Surbakti T., Hartanto D. Kinetics Parameters Evaluation on the First Core of the RSG GAS (MPR-30) Using Continuous Energy Monte Carlo Method. *Prog. Nucl. Energy.* 2018. **109**: 196-203.
- Tashakor S., Zarifi E., Naminazari M. Neutronic Simulation of CAREM-25 Small Modular Reactor. *Prog. Nucl. Energy.* 2017. **99**: 185-195.
- Surbakti T., Pinem S., Suparlina L. Dynamic Analysis on the Safety Criteria of the Conceptual Core Design in MTR-type Research Reactor. *Atom Indones.* 2018. **44**(2): 89-97.
- Pinem S., Sembiring T.M., Surbakti T. Core Conversion Design Study of TRIGA Mark 2000 Bandung Using MTR Plate Type Fuel Element. *Int. J. Nucl. Energy Sci. Technol.* 2018. **12**(3): 222-238.
- Surbakti T., Purwadi P. Analysis of Neutronic Safety Parameters of the Multi-Purpose Reactor–Gerrit Augustinus Siwabessy (RSG-GAS) Research Reactor at Serpong. *J. Penelit. Fis. dan Apl.* 2019. **9**(1): 78-91.
- Savva P., Varvayanni M., Catsaros N. Dependence of Control Rod Worth on Fuel Burnup. *Nucl. Eng. Des.* 2011. **241**(2): 492-497.
- Kazeminejad H. Thermal-hydraulic Modeling of Reactivity Insertion in a Research Reactor. *Ann. Nucl. Energy.* 2012. **45**: 59-67.
- Rahimi G., Nematollahi M.R., Hadad K., Rabiee A. Conceptual Design of a High Neutron Flux Research Reactor Core with Low Enriched Uranium Fuel and Low Plutonium Production. *Nucl. Eng. Technol.* 2020. **52**(3): 499-507.
- Surbakti T., Pinem S., Sembiring T.M., Hamzah A., Nabeshima K. Calculation of Control Rods Reactivity Worth of RSG-GAS First Core Using Deterministic and Monte Carlo Methods. *Atom Indones.* 2019. **45**(2): 69-79.
- Surbakti T., Pinem S., Sembiring T.M., Subekti M., Sunaryo G.R. Preliminary Study for Alternative Conceptual Core Design of the MTR Research Reactor. *J. Phys. Conf. Ser.* 2018. **962**(1)
- Pinem S., Sembiring T.M., Liem P.H. Neutronic and Thermal-Hydraulic Safety Analysis for the Optimization of the Uranium Foil Target in the RSG-GAS Reactor. 2016. **42**(3): 123-128.
- Pinem S., Liem P.H., Sembiring T.M., Surbakti T. Fuel Element Burnup Measurements for the Equilibrium LEU Silicide RSG GAS (MPR-30) Core Under a New Fuel Management Strategy. *Ann. Nucl. Energy.* 2016. **98**: 211-217.
- Surbakti T., Imron M. Fuel Burn-Up Calculation for Working Core of the RSG-GAS Research Reactor at Batan Serpong. *J. Penelit. Fis. dan Apl.* 2017. **7**(2): 89-101.
- Sheets N.D., Brookhaven M., Mughabghab S., National B., Talou P., National L.A., et al. ENDF / B-VII . 1 Nuclear Data for Science and Technology : Cross Sections , Covariances , Fission Product Yields and Decay. 2017.

